

bushing current-transformer

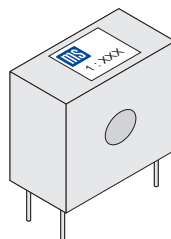

03.01 - 03.02

bushing current-transformer MR15/5

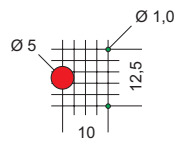
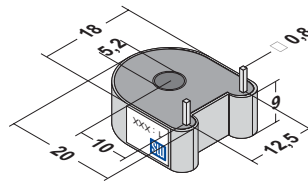

view on pin side
pin grid= 2,5 mm

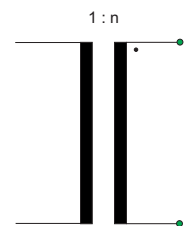

winding schematic

| order-nr | input | turns-ratio | I max | rated inductance |
|----------|-------|-------------|-------|------------------|
| MS4431 | n = 1 | 1 : 200 | 40 A | ca. 100 mH |
| MS4431-1 | n = 1 | 1 : 100 | 40 A | ca. 25 mH |
| MS4431-2 | n = 1 | 1 : 50 | 40 A | ca. 6 mH |

technical datas:

| | |
|------------------------|---------------|
| rated current primary: | 40 A |
| rated frequency: | until 100 kHz |
| rated impedance: | 100 - 200 Ohm |
| turn-on-time: | 100% |
| temperature-class: | E (120°C) |
| test-voltage | 5 kV |
| construction: | potted |

bushing current-transformer, 50 Hz

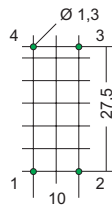
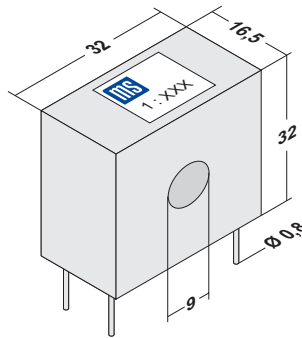

view on pin side
pin grid = 5 mm

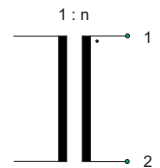

schematic

| order-nr | input | turns-ratio | I max | I sec |
|----------|-------|-------------|-------|-------|
| MS4270 | n = 1 | 1 : 3000 | 30 A | 10 mA |
| MS4270-1 | n = 1 | 1 : 1500 | 30 A | 20 mA |
| MS4270-2 | n = 1 | 1 : 750 | 30 A | 40 mA |

technical datas:

| | |
|--------------------------|------------|
| rated current secondary: | 10 mA |
| rated power | 100 mVA |
| rated frequency: | 50 / 60 Hz |
| rated impedance | 1 kOhm |
| turn-on-time: | 100% |
| temperatue-class: | B (130°C) |
| test-voltage | 5 kV |
| construction: | potted |